

# PRODUCT GUIDE



SOR sales partner discusses level solution alternatives with food process engineer at Rancagua, Chile plant.



### Who we are

SOR Controls Group, LTD (SCG) is a global leader in the design and manufacture of measurement and control devices under the brands of SOR Inc., Smart Sensors (SSi), SETEX Products and SENSOR Sampling and Data Monitoring Systems. SOR Controls Group actively serves all sectors of the process industry with particular strengths in the oil & gas, petrochemical, chemical and power segments. SCG supports a network of sales and service personnel capable of addressing customer requirements in any geographic market around the world.

### One of the Best Machine Shops in America

Our manufacturing facilities include more than 85,000 square feet of vertically integrated production capability and we are proud of having our Lenexa, Kansas machine shop voted one of the top 10 in the United States by the American Machinist magazine. With decades of experience manufacturing measurement and control products, we have designs for thousands of unique applications around the world.

### Engineered to Order with Off-the-Shelf Speed

The exact instrument you need delivered when you need it. It's what SOR® has built its reputation on since 1946. SOR has enjoyed the distinction of meeting the challenges of the measurement and control industry for many years. We provide the most reliable electronic and electromechanical pressure, level, temperature and flow instruments available.

### Customer Service is Our Focus

SOR is dedicated to reducing product lead times and has LEAN initiatives in place to continuously improve the quality and delivery of products we provide to you. We know that no two applications are exactly the same. We work one-on-one with customers all over the world to meet their individual application challenges and obstacles. While this Product Guide provides the specifications and options available for SOR products, our global Representatives organization and factory Sales Engineers also stand ready to help you get the right device for the job. Just give us a call.



**245 Team  
Members  
Worldwide**



**Sales Offices in  
Beijing, Dubai,  
Chennai, London,  
Lenexa & Houston**



**Manufacturing  
Locations in  
Lenexa, KS  
& Houston, TX**



**Exports into  
75 Countries**

Design and specifications are subject to change without notice.  
For the latest revisions, visit [SORInc.com](http://SORInc.com).

# Table of Contents

|                              |  |    |
|------------------------------|--|----|
| <b>Pressure</b>              | Switches_ . . . . .                                    | 2  |
|                              | Differential Switches_ . . . . .                       | 4  |
|                              | Transmitters_ . . . . .                                | 6  |
| <b>Temperature</b>           | Switches_ . . . . .                                    | 7  |
|                              | Sensors_ . . . . .                                     | 8  |
| <b>Level</b>                 | Transmitters & Indicators_ . . . . .                   | 9  |
|                              | Flushing Rings_ . . . . .                              | 9  |
|                              | Switches_ . . . . .                                    | 10 |
| <b>Valves &amp; Controls</b> | Control Valves_ . . . . .                              | 12 |
|                              | Level Controllers_ . . . . .                           | 12 |
|                              | Pressure Regulators_ . . . . .                         | 13 |
| <b>Nuclear Qualified</b>     | Switches_ . . . . .                                    | 14 |
| <b>Flow</b>                  | Switches_ . . . . .                                    | 15 |
|                              | Transmitters_ . . . . .                                | 15 |
| <b>Systems</b>               | Sampling Systems_ . . . . .                            | 16 |
|                              | Data Monitoring_ . . . . .                             | 17 |
| <b>Engineered to Order</b>   | Engineering & Manufacturing Capabilities_ . . . . .    | 18 |
|                              | Diaphragm Seals_ . . . . .                             | 20 |
|                              | Classifications, Certifications & Approvals_ . . . . . | 21 |
|                              | General Applications_ . . . . .                        | 23 |



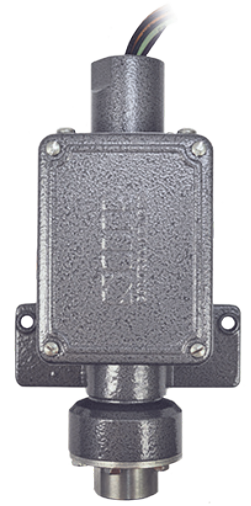
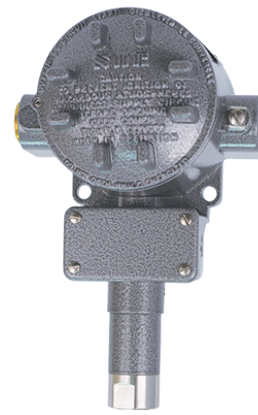

### NN

**Weatherproof**  
(Pressure/Vacuum/  
Compound)



30 inHg vac to 7000 psi  
1 bar vac to 480 bar

**3 YEAR WARRANTY**

- Low cost
- Set point adjustment with calibrated scale
- Pivot seal version for high pressure available
- For more information, see [Catalogs 216 & 219](#)

### RN

**Weatherproof, Terminal Block Connections**  
(Pressure/Vacuum/  
Compound)



30 inHg vac to 7000 psi  
1 bar vac to 480 bar

**3 YEAR WARRANTY**

- Low cost
- Set point adjustment with calibrated scale
- Terminal block connections
- For more information, see [Catalogs 216 & 219](#)

### L

**Explosion Proof**  
(Pressure/Vacuum/  
Compound)



30 inHg vac to 7000 psi  
1 bar vac to 480 bar

**3 YEAR WARRANTY**

- Low cost
- Set point adjustment with calibrated scale
- Explosion proof rated as outlet box
- For more information, see [Catalogs 216 & 219](#)

### B3

**Explosion Proof, UL/CSA/ATEX**  
(Pressure/Vacuum/  
Compound)



30 inHg vac to 7000 psi  
1 bar vac to 480 bar

**3 YEAR WARRANTY**

- Terminal block connections
- Set point adjustment with calibrated scale
- Set point adjustment without declassification of hazardous area
- For more information, see [Catalogs 216 & 219](#)

### BIG HERMET

**Explosion Proof, Hermetically Sealed**  
(Pressure/Vacuum/  
Compound)



30 inHg vac to 7000 psi  
1 bar vac to 480 bar

**3 YEAR WARRANTY**

- Complete pressure range offering
- Hermetically sealed snap switch(es)
- Set point adjustment with calibration scale
- Set point adjustment without declassification of hazardous area
- For more information, see [Catalogs 455 & 219](#)

# PRESSURE SWITCHES

Today's SOR Pressure Switches are the descendants of the original Static "O" Ring® mechanical pressure switches that set industry standards more than 50 years ago. They are field-proven, low cost process instruments for use as either primary or redundant pressure or flow monitoring applications in a wide variety of industries.





**MINI-HERMET**  
Explosion Proof,  
Hermetically Sealed  
(Pressure/Compound)



30 inHg vac to 7000 psi  
1 bar vac to 480 bar  
3 YEAR WARRANTY

- Compact, explosion proof switch
- Hermetically sealed snap switch(es)
- Set point adjustment without declassification of hazardous area
- For more information, see [Catalogs 456 & 219](#)



**V1**  
Weatherproof  
(Pressure/Vacuum/  
Compound)



30 inHg vac to 4000 psi  
1 bar vac to 275 bar  
3 YEAR WARRANTY

- Two independent switches sharing same housing and port
- Dual set points available
- Set point adjustment with calibrated scale
- Adjustable dead band on some models
- For more information, see [Catalogs 217 & 281](#)



**V2**  
Explosion Proof,  
Hermetically Sealed  
(Pressure/Vacuum/  
Compound)



30 inHg vac to 4000 psi  
1 bar vac to 275 bar  
3 YEAR WARRANTY

- Two independent switches sharing same housing and port
- Dual set points available
- Hermetically sealed snap switch(es)
- Adjustable dead band on some models
- Set point adjustment without declassification of hazardous area
- For more information, see [Catalogs 217 & 281](#)



**SUB-MINI-HERMET**  
Explosion Proof,  
Hermetically Sealed  
(Pressure)



8 to 200 psi  
0.5 to 14 bar  
3 YEAR WARRANTY

- Low cost explosion proof switch
- Hermetically sealed snap switch(es)
- Set point adjustment without declassification of hazardous area
- For more information, see [Catalog 987](#)



**805QS**  
Explosion Proof  
(Pressure)



0-5 to 0-30,000 psi  
0-0.34 to 0-2068 bar  
3 YEAR WARRANTY

- Solid state switch output
- Stainless steel sensor
- Compact, 316 stainless steel enclosure
- Supplemental continuous 4-20 mA or 1-5 VDC output
- For more information, see [Catalog 1552](#)



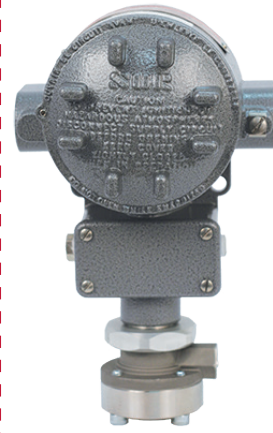

**NN**

**Weatherproof**  
(Single diaphragm)



3 to 500 psid  
0.2 to 35 bar

3 YEAR WARRANTY

- Low cost
- Set point adjustment with calibrated scale
- For more information, see [Catalog 468](#)

**RN**

**Weatherproof, Terminal Block Connections**  
(Single diaphragm)



3 to 500 psid  
0.2 to 35 bar

3 YEAR WARRANTY

- Terminal block connections
- Set point adjustment with calibrated scale
- For more information, see [Catalog 468](#)

**L**

**Explosion Proof**  
(Single diaphragm)



3 to 500 psid  
0.2 to 35 bar

3 YEAR WARRANTY

- Low cost
- Set point adjustment with calibrated scale
- Explosion proof rated as outlet box
- For more information, see [Catalog 468](#)

**B3**

**Explosion Proof, UL/CSA/ATEX**  
(Single diaphragm)



3 to 500 psid  
0.2 to 35 bar

3 YEAR WARRANTY

- Terminal block connections
- Set point adjustment with calibrated scale
- Set point adjustment without declassification of hazardous area
- For more information, see [Catalog 468](#)

**BIG HERMET**

**Explosion Proof, Hermetically Sealed**  
(Single diaphragm)



3 to 500 psid  
0.2 to 35 bar

3 YEAR WARRANTY

- Hermetically sealed snap switch(es)
- Set point adjustment with calibration scale
- Set point adjustment without declassification of hazardous area
- For more information, see [Catalog 468](#)

# DIFFERENTIAL PRESSURE SWITCHES

Accuracy, multi-use flexibility and the ability to match the instrument to the application distinguish SOR differential pressure switches from off-the-shelf products. Standard models are available in weatherproof and explosion proof configurations and can include an external set point adjustment mechanism for simplified calibration.



**MINI-HERMET**  
Explosion Proof,  
Hermetically Sealed  
(Single diaphragm)



3 to 500 psid  
0.2 to 35 bar

3 YEAR WARRANTY

- Compact low cost explosion proof switch
- Hermetically sealed snap switch(es)
- Set point adjustment without declassification of hazardous area
- For more information, see [Catalog 468](#)



**RB**  
Weatherproof  
(Dual diaphragm,  
opposed piston)



0.5 to 1000 psid  
35 mbar to 70 bar

3 YEAR WARRANTY

- Separate pressure ports to customize material and size
- Terminal block connections
- Set-point adjustment with calibrated scale
- For more information, see [Catalog 386](#)

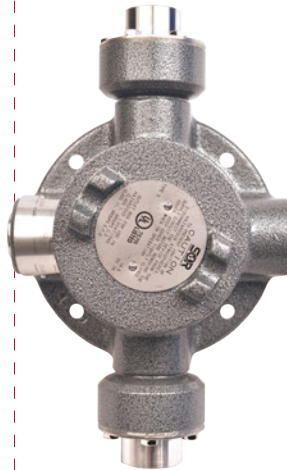

**S**  
Explosion Proof  
(Dual diaphragm,  
opposed piston)



0.5 to 1000 psid  
35 mbar to 70 bar

3 YEAR WARRANTY

- Separate pressure ports to customize material and size
- Set-point adjustment with calibrated scale
- For more information, see [Catalog 386](#)

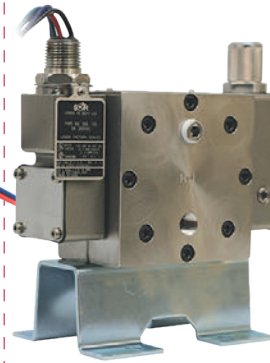

**102 & 103**  
Explosion Proof,  
Hermetically Sealed  
(High-static operation)



7 inwc to 2500 psid  
18 mbar to 175 bar

3 YEAR WARRANTY

- High static pressures at low differential set points
- Negligible temperature and/or static influence
- Hermetically sealed snap switch(es)
- Weatherproof version available
- For more information, see [Catalog 388](#)

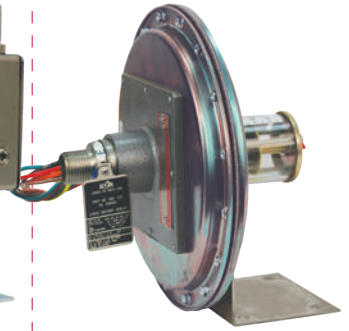

**107**  
Explosion Proof,  
Hermetically Sealed  
(Low range)



0 to 40 inwc  
0 to 1000 mmwc

3 YEAR WARRANTY

- Highly accurate low range for draft applications
- Set point adjustment with calibrated scale
- Hermetically sealed snap switch(es)
- Weatherproof version available
- For more information, see [Catalog 459](#)

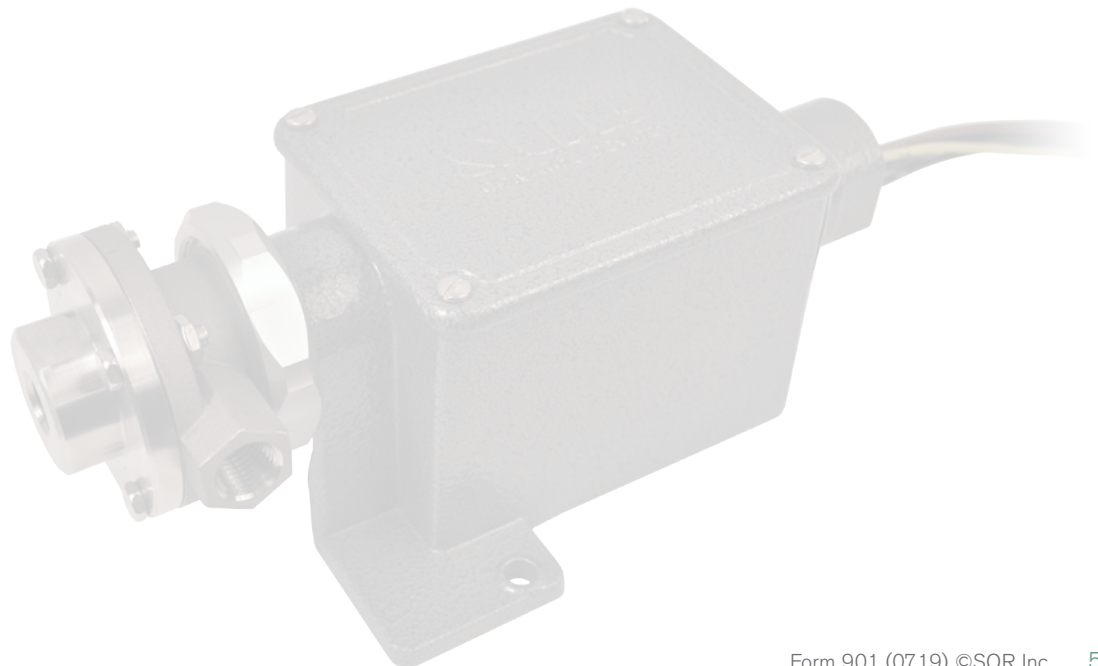



**805PT**  
Explosion Proof  
(Gauge and Absolute)

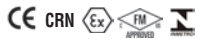

0-5 to 0-30,000 psi  
0-0.34 to 0-2068 bar

3 YEAR WARRANTY

- Compact, 316 stainless steel enclosure
- Stainless steel sensor
- +/-0.25% (URL) continuous output accuracy
- 4-20mA or 1-5 VDC output
- LCD explosion proof display option available
- Available for quick delivery in 48 hours
- For more information, see [Catalog 1552](#)



**805QS**  
Explosion Proof  
(Gauge and Absolute)



0-5 to 0-30,000 psi  
0-0.34 to 0-2068 bar

3 YEAR WARRANTY

- Solid state switch output
- Compact, 316 stainless steel enclosure
- Stainless steel sensor
- +/-0.25% (URL) continuous output accuracy
- 4-20mA or 1-5 VDC output
- Supplemental continuous output
- LCD explosion proof display option available
- For more information, see [Catalog 1552](#)



**815PT**  
Explosion Proof  
(Gauge and Absolute)



0-5 to 0-30,000 psi  
0-0.34 to 0-2068 bar

3 YEAR WARRANTY

- HART®7
- Modbus RTU (RS-485)
- Compact, 316 stainless steel enclosure
- Stainless steel sensor
- +/-0.10% (URL) continuous output accuracy
- 4-20mA and/or 1-5 VDC output
- 9-way configurable solid state switch output
- LCD explosion proof display option available
- Available for quick delivery in 48 hours
- For more information, see [Catalog 1587](#)



**815DT**  
Explosion Proof  
(Differential)



5 to 500 psid  
0-0.34 to 0-35 bar

3 YEAR WARRANTY

- HART®7
- Modbus RTU (RS-485)
- Compact, 316 stainless steel enclosure
- Stainless steel sensor
- +/-0.10% (URL) continuous output accuracy
- 4-20mA and/or 1-5 VDC output
- 9-way configurable solid state switch output
- LCD explosion proof display option available
- Available for quick delivery in 48 hours
- For more information, see [Catalog 1587](#)



**815LT**  
Submersible  
Hydrostatic Pressure  
(Gauge)



7 to 575 ft. w.c.  
(2.1 to 175.5 mw.c.)

3 YEAR WARRANTY

- IP68 housing submersible up to 1200 ft.
- Cage option to protect sensors from solids and prevent build-up
- Vent tube for reference to atmospheric pressure
- HART®7
- Modbus RTU (RS-485)
- Compact, 316 stainless steel enclosure
- +/-0.10% (URL) continuous output accuracy
- 4-20mA and/or 1-5 VDC output
- 9-way configurable solid state switch output
- LCD explosion proof display option available
- For more information, see [Catalog 1735](#)

# PRESSURE TRANSMITTERS

"Set it and forget it" reliability makes SOR pressure transmitters perfect for applications where space is tight. Our stainless steel construction stands up to the rigors of hostile environments and hazardous locations. SOR transmitters have adjustable ranges and are available with 4-20mA, 1-5VDC, HART®7 and/or Modbus RTU protocol outputs.





**NN**

**Weatherproof**  
(Direct or remote mount)



-50° to 1000°F  
-45° to 540°C

3 YEAR WARRANTY

- Low Cost
- Set point adjustment with calibrated scale
- For more information, see [Catalog 220](#)



**RN**

**Weatherproof, Terminal Block Connections**  
(Direct or remote mount)



-50° to 1000°F  
-45° to 540°C

3 YEAR WARRANTY

- Terminal block connections
- Set point adjustment with calibrated scale
- For more information, see [Catalog 220](#)



**B3**

**Explosion Proof, UL/CSA/ATEX**  
(Direct or remote mount)



-50° to 1000°F  
-45° to 540°C

3 YEAR WARRANTY

- Terminal block connections
- Set point adjustment with calibrated scale
- Set point adjustment without declassification of hazardous area
- For more information, see [Catalog 220](#)

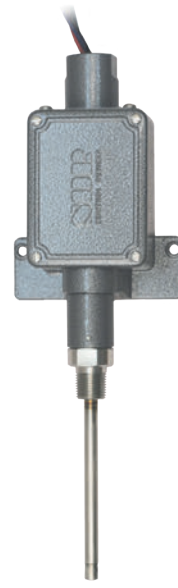

**BIG HERMET**  
**Explosion Proof Hermetically Sealed**  
(Direct or remote mount)



-50° to 1000°F  
-45° to 540°C

3 YEAR WARRANTY

- Hermetically sealed snap switch(es)
- Set point adjustment with calibrated scale
- Set point adjustment without declassification of hazardous area
- For more information, see [Catalog 220](#)



**MINI-HERMET**  
**Explosion Proof Hermetically Sealed**  
(Direct or remote mount)



-50° to 1000°F  
-45° to 540°C

3 YEAR WARRANTY

- Hermetically sealed snap switch(es)
- Set point adjustment without declassification of hazardous area
- For more information, see [Catalog 220](#)

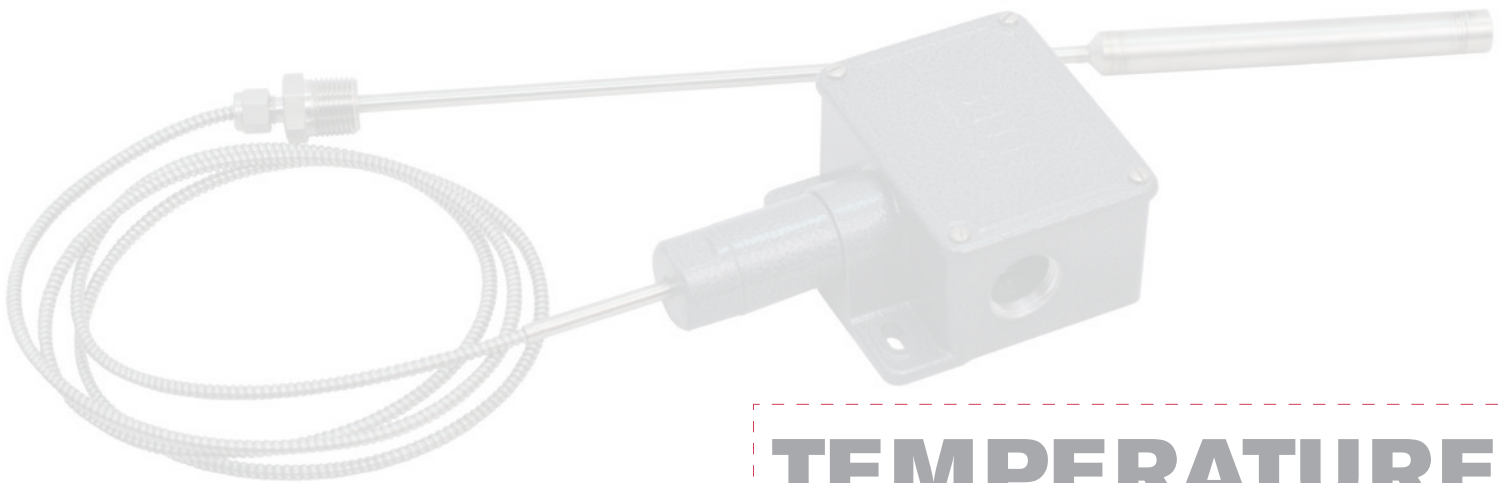

When you need a quick response, choose SOR temperature switches. They consistently lead the industry in sales year after year because of their small dead band ranges and legendary reliability.

# TEMPERATURE SWITCHES

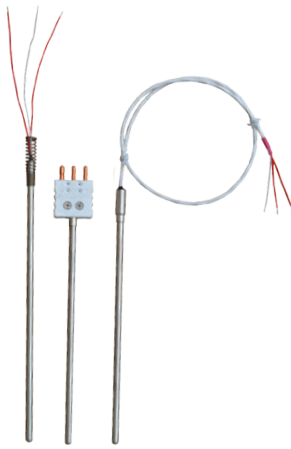

## RTDs

1 YEAR WARRANTY

- 316SS sheath material standard
- Type 1150 with plug for direct termination
- Type 1250 with wire extended leads for remote termination
- Industrial style suited for both temperatures up to 900°F (482°C) and cryogenic applications down to -200°F (-124°C)
- Field adjustable style can be cut to length down to 3" minimum
- All RTDs receive 100% accuracy and continuity testing
- Field adjustable and industrial styles supplied with heavy duty spring
- For more information, see [Catalog 1667](#)

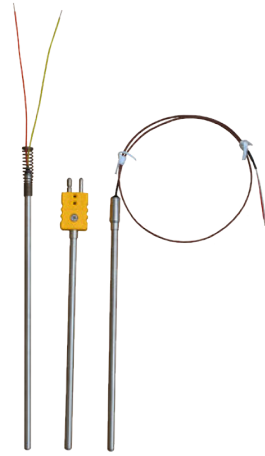

## THERMOCOUPLES

1 YEAR WARRANTY

- 316SS sheath material standard
- Type 1100 with plug for direct termination
- Type 1200 with wire extended leads for remote termination
- Calibration types J, K, T, E, N, R, S, B available
- Field adjustable style can be cut to length down to 3" minimum
- Industrial and field adjustable styles supplied with heavy duty spring
- For more information, see [Catalog 1667](#)

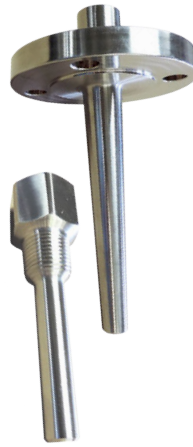

## THERMOWELLS

1 YEAR WARRANTY

- Manufactured and assembled with sensor to prevent being shipped with incorrect mating dimensions
- Threaded, Flanged, Socket Weld, Sanitary, Weld-in and Van Stone connections available
- Offered with straight, tapered or step-down well shank
- Pipe tube well configuration also available
- Can be constructed in a wide variety of common and exotic materials
- For more information, see [Catalog 1667](#)



## SENSOR ASSEMBLIES

1 YEAR WARRANTY

- Versatile design can be inserted into an existing thermowell
- Sensor protection with optional thermowell/tubewell constructed to your specifications
- Optional connection heads suited for general purpose or explosion proof applications
- Multipoint sensor assemblies provide more complete temperature profiles for multiple measuring points required over broad range
- Vast customization capability with wide array of accessories
- Specialty sensors available, such as Surface Mount, Pipe Clamp, Tubeskin, Oil Seal and more
- For more information, see [Catalog 1667](#)



## TRANSMITTERS

3 YEAR WARRANTY

- Accepts RTD and Thermocouple inputs
- Full access to all features while in operation
- Optional LCD display with loop or battery-powered, suited for general purpose and explosion proof applications
- All types are programmable
- 4-20mA output, optional HART communications protocol
- For more information, see [Catalog 1667](#)

# TEMPERATURE SENSORS

SOR manufactures a complete line of thermocouple elements, RTD sensors, thermowells, industrial assemblies and specialty temperature sensors. Products include multipoint temperature sensors, sanitary RTDs, high temperature furnace thermocouples, surface/tubeskin thermocouples and so much more to suit a wide variety of industrial applications and OEM markets with both demanding and general purpose temperature measurement requirements.



**815LT**  
Submersible  
Hydrostatic Pressure  
(Gauge)

7 to 575 ft. w.c.  
(2.1 to 175.5 mw.c.)

3 YEAR WARRANTY

- IP68 housing submersible up to 1200 ft.
- Cage option to protect sensors from solids and prevent build-up
- Vent tube for reference to atmospheric pressure
- HART®7
- Modbus RTU (RS-485)
- Compact, 316 stainless steel enclosure
- +/-0.10% (URL) continuous output accuracy
- 4-20mA and/or 1-5 VDC output
- 9-way configurable solid state switch output
- LCD explosion proof display option available
- For more information, see [Catalog 1735](#)



**815DT**  
Explosion Proof  
(Differential)



0-5 to 500 psid  
0.34 to 0-35 bar

3 YEAR WARRANTY

- 21 point strapping table for non-linear tank geometries
- HART®7
- Modbus RTU (RS-485)
- Compact, 316 stainless steel enclosure
- Stainless steel sensor
- +/-0.10% (URL) continuous output accuracy
- 4-20mA and/or 1-5 VDC output
- 9-way configurable solid state switch output
- LCD explosion proof display option available
- Available for quick delivery in 48 hours
- For more information, see [Catalog 1587](#)



**670**  
**SERIES**  
RF



Up to 19.5 ft.  
(5.9m)

3 YEAR WARRANTY

- Continuous level measurement transmitter
- Measurement range up to 19.5 ft.
- Loop-powered, intrinsically safe 4-20mA output
- A variety of probe configurations meet most application conditions
- For more information, see [Catalog 1100](#)



**1100 SERIES**  
Magnetic  
Level Indicators

CRN

vac to 5000 psi  
vac to 345 bar

-320 to 1000°F  
-196 to 538°C

5 YEAR WARRANTY

- 0.35 min. specific gravity
- 200° viewing angle with patented *vista*™ indicator (U.S. Patent #14/638,990)
- Designed to ANSI/ASME B31.1 and B31.3 guidelines
- Each float designed to meet process temperatures, pressure and specific gravities
- Floats hydrotested to 1.5X rating and shipped inside chamber for easy commissioning
- A wide variety of indicator flag colors are available
- For more information, see [Catalog 1596](#)



**1010FR**  
Flushing Rings

1/2", 3/4", 1", 1-1/2", 2", 3", 4"  
Standard Ring Sizes

CS or 316SS Standard  
Ring Construction

5 YEAR WARRANTY

- Universal fit with any device on the market
- Can be supplied with welded valve assemblies
- Available in a wide variety of standard and exotic materials
- NACE option available
- Inspections and testing certifications done to SOR standard or your specific requirements
- For more information, see [Catalog 1737](#)

SOR level transmitters and indicators continuously sense the liquid level in tanks and deliver a 4-20mA current proportional to the level and/or the patented *vista*™ indicator (U.S. Patent #14/638,990).

The current output can be connected to a programmable logic controller, computer, remote display or relay module to display and/or control the liquid level in the tank. Depending on the model you choose monitoring may be accomplished without contacting the process. Our level transmitters may be used as a point or continuous level measurement device.

# LEVEL TRANSMITTERS & INDICATORS



**100 SERIES,  
741-743, 802**  
Flanged Chamber



vac to 3600 psi  
vac to 248 bar

-65° to 1200°F  
-54° to 649°C

5 YEAR WARRANTY

- Serviceable flanged chamber
- Stainless steel switching mechanism for harsh atmospheres
- Electromechanical & pneumatic switching mechanisms offered
- For more information, see [Catalog 912](#)



**200 SERIES,  
740, 804**  
Sealed Chamber



vac to 3728 psi  
vac to 257 bar

-65° to 1200°F  
-54° to 649°C

5 YEAR WARRANTY

- Low cost sealed chamber
- Stainless steel switching mechanism for harsh atmospheres
- Electromechanical & pneumatic switching mechanisms offered
- For more information, see [Catalog 912, 1414](#)



**700 SERIES,  
730 & 750 SERIES**  
Top Mounted  
Displacer



vac to 1000 psi  
vac to 69 bar

-65° to 450°F  
-54° to 232°C

5 YEAR WARRANTY

- Available in 1, 2 or 3-stage switching
- Narrow and wide differential
- Stainless steel switching mechanism for harsh atmospheres
- Electromechanical & pneumatic switching mechanisms offered
- For more information, see [Catalog 912](#)



**300 SERIES**  
Top Mounted Float



vac to 750 psi  
vac to 51 bar

-65° to 1200°F  
-54° to 649°C

5 YEAR WARRANTY

- Available in 1- or 2-stage switching
- Stainless steel switching mechanism for harsh atmospheres
- Electromechanical & pneumatic switching mechanisms offered
- For more information, see [Catalog 912](#)



**400 SERIES**  
Side Mounted Float



vac to 1250 psi  
vac to 86 bar

-65° to 1200°F  
-54° to 649°C

5 YEAR WARRANTY

- Horizontal side mounted float
- Stainless steel switching mechanism for harsh atmospheres
- Electromechanical & pneumatic switching mechanisms offered
- For more information, see [Catalog 912](#)

# LEVEL SWITCHES

SOR level switches have earned a long-time reputation for their high quality, rugged construction and reliable performance under the most demanding applications. All level switches are individually built with strict attention to detail to meet the exact specifications of your process.





**108 & 208**  
Steam Trap Chamber



vac to 2248 psi  
vac to 155 bar  
-65° to 1200°F  
-54° to 649°C

5 YEAR WARRANTY

- Serviceable flanged or sealed chamber
- Stainless steel switching mechanism for harsh atmospheres
- Electromechanical & pneumatic switching mechanisms offered
- For more information, see [Catalog 912](#)



**1500 SERIES**  
Compact Level



vac to 5000 psi  
vac to 345 bar  
-40° to 400°F  
-40° to 204°C

5 YEAR WARRANTY

- Economical side and top mounted versions available
- Stainless steel switch housing for harsh atmospheres
- Low cost sealed chamber available
- Explosion proof
- For more information, see [Catalogs 498, 850 & 1337](#)



**1710, 2210**  
Compact Level



vac to 1799 psi  
vac to 124 bar  
-40° to 750°F  
-40° to 399°C

5 YEAR WARRANTY

- Stainless steel switching mechanism for harsh atmospheres
- Low cost sealed chamber available
- Explosion proof
- "Quick release" threaded cover
- For more information, see [Catalogs 864](#)



**701, 711, 721, 712 & 722**  
Single & Dual Point  
Ultrasonic



0 to 2000 psi  
0 to 135 bar  
-40° to 250°F  
-40° to 121°C

3 YEAR WARRANTY

- Low cost
- No calibration required
- Relay and current shift (8/16mA) output available
- 316SS sensor
- Dual set point available
- For more information, see [Catalog 1145](#)



**651 & 681**  
Single Point RF  
**660 SERIES**  
Multipoint RF



0 to 2000 psi  
0 to 135 bar  
-100° to 400°F  
-73° to 204°C

3 YEAR WARRANTY

- Low cost
- Single point switch for alarm applications
- Relay and current shift (8/16mA) output available
- Up to four points level indication for both high and low level alarms
- Adjustable differential feature provides for pump control
- A variety of probe configurations meet most application conditions
- For more information, see [Catalog 1100](#)





**1450**  
Control Valve

CRN

vac to 3750 psi  
vac to 259 bar

-40 to 200°F  
-40 to 93°C

1 YEAR WARRANTY

- Bonnet safety pressure relief
- NACE available
- Optional tungsten carbide hardened trim for erosive applications
- Reverse and direct acting options
- Electronic actuator option available
- For more information, see [Catalog 1639](#)



**1451**  
Control Valve

CRN

vac to 2220 psi  
vac to 153 bar

-40° to 200°F  
-40° to 93°C

1 YEAR WARRANTY

- Direct insertion into tank to prevent valve freezing
- NACE option available
- Stainless steel trim
- Compact size
- For more information, see [Catalog 1639](#)



**1600 SERIES**  
Liquid Level Controllers

CRN

vac to 6000 psi  
vac to 414 bar

-40° to 400°F  
-40° to 204°C

1 YEAR WARRANTY

- Controller case is easily field reversible
- Well suited for liquid-liquid interface detection
- Non-Bleed pilot available to meet strict EPA regulations
- NACE option available
- Field selectable vertical or horizontal displacer configuration
- Electronic switch option with explosion proof ratings available
- For more information, see [Catalog 1637](#)



# VALVES & CONTROLLERS

Valves and controls are designed and manufactured by SOR to be used in rugged and demanding applications like those found in the oil and gas industry. Each instrument is designed to provide superior performance and to solve industry specific challenges. SOR instruments have been proven over time to deliver increased reliability in the most demanding applications around the world.



**1267AFR**  
Air Filter Regulator

0 to 30 psi (0-2 bar)  
0 to 60 psi (0-4 bar)  
0 to 120 psi (0-8 bar)

18 MONTH WARRANTY

- 1/4" NPT or 1/2" NPT (high flow capacity) inlet & outlet ports
- Low air consumption for lower operating costs
- NACE option available
- 250 psi (17 bar) max inlet pressure
- For more information, see [Catalog 1631](#)



**1201HPR**  
High Pressure Regulator

CRN  
0 to 30 psi (0-2 bar)  
0 to 60 psi (0-4 bar)  
0 to 120 psi (0-8 bar)  
0 to 150 psi (0-10 bar)  
0 to 225 psi (0-15 bar)

1 YEAR WARRANTY

- Brass or stainless steel construction
- 3 outlet ports can regulate pressure to 3 devices
- Optional T-handle adjustment method
- 5000 psi (345 bar) max inlet pressure
- For more information, see [Catalog 1631](#)



**1227LRG**  
Little Pressure Regulator

CRN  
5 to 20 psi (0.4-1.4 bar)  
15 to 40 psi (1-2.8 bar)  
35 to 80 psi (2.4-5.5 bar)  
70 to 150 psi (4.8-10.3 bar)

1 YEAR WARRANTY

- 1" or 2" body size
- Aluminum or stainless steel trim
- NACE option available
- Coming soon to [Catalog 1631](#)

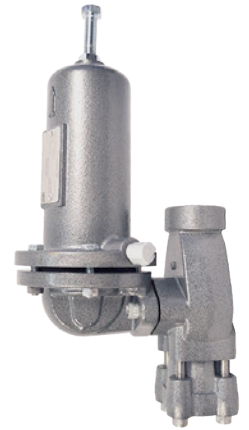

**1230BRG**  
Big Pressure Regulator

CRN  
27 to 50 psi (1.9-3.5 bar)  
46 to 95 psi (3.2-6.6 bar)  
90 to 150 psi (6.2-10.3 bar)  
150 to 200 psi (10.3-13.8 bar)  
200 to 275 psi (13.8-19 bar)  
275 to 500 psi (19-34.5 bar)

1 YEAR WARRANTY

- 1" or 2" body size
- Brass or stainless steel trim
- NACE option available
- Coming soon to [Catalog 1631](#)



SOR pressure regulators are designed to provide accurate supply pressure to instruments, valves and other automatic control equipment. These instruments are constructed of durable materials that will provide a long lasting performance in industrial environments.

# PRESSURE REGULATORS

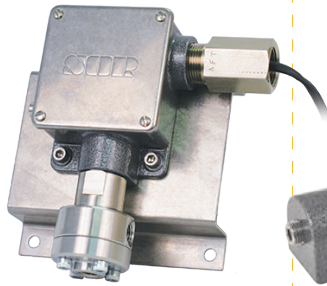

**131 & 141**  
**Differential Pressure**  
**Switches**

5" wcd to 180 psid  
 13 mbar to 12.4 bard

1 YEAR WARRANTY

- 1E qualified
- Long-term stability
- Negligible temperature effect
- HELB tested to 33Mrad
- Quick delivery
- For more information see [Catalog 1291](#)

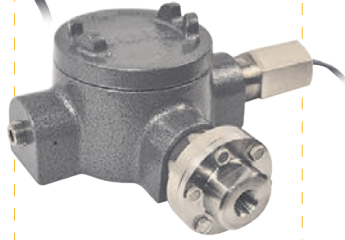

**N6, RT, TA**  
**Pressure Switches**

30" HgV to 1750 psi  
 1000 mbar to 120 bar

1 YEAR WARRANTY

- Carbon and stainless steel housing for HELB tested to 33Mrad
- Ductile iron housing for LOCA tested to 200Mrad
- Threaded cover with double environmental seal
- Vent connection provided if needed
- Terminal block connections if needed
- Engineered to meet your specifications
- For more information see [Catalog 651](#)

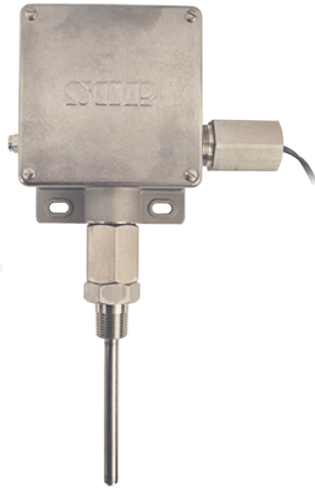

**N6, RT, TA**  
**Temperature Switches**

40° to 375°F  
 5° to 190°C

1 YEAR WARRANTY

- Carbon, ductile iron, and stainless steel housing for HELB tested to 33Mrad
- Threaded cover with double environmental seal
- Vent connection provided if needed
- Terminal block connections if needed
- Engineered to meet your specifications
- For more information see [Catalog 651](#)

# NUCLEAR QUALIFIED PRODUCTS

SOR custom engineers nuclear-qualified pressure, temperature, differential and vacuum switches. Our engineering expertise is specifically targeted to meet the unique demands of the nuclear power generation industry and provide solutions.







**T21**  
Thermal Differential

CRN RTN

-100° to 392°F  
-70° to 200°C

Gases up to 500 ft/second  
Liquids up to 5 ft/second

1 YEAR WARRANTY

- Wide operating process temperature range
- Designed for liquid and gas flow applications
- Removable, plug-in electronics board
- Self-heating sensor design
- For more information, see [Catalog 1021](#)



**900 SERIES**  
Vane Operated

RTN

vac to 1480 psi  
vac to 102 bar

-15° to 250°F  
-26° to 121°C

5 YEAR WARRANTY

- Stainless steel switching mechanism for harsh atmospheres
- All ASTM materials construction
- Flow monitoring for a wide range of pipe sizes and specific gravities
- For more information, see [Catalog 672](#)



**1520**  
OEM

CRN

vac to 5000 psi  
vac to 345 bar

-40 to 400°F  
-40 to 204°C

5 YEAR WARRANTY

- All stainless steel construction
- Standard product rating of 1500 psi @ (-40°F to 400°F), 100 bar @ -40°C to 204°C
- For more information, see [Catalog 499](#)



**815DT**  
Explosion Proof  
(Differential)

CRN

5 to 500 psid  
0-0.34 to 0-35 bard

3 YEAR WARRANTY

- Square root output available
- HART®7
- Modbus RTU (RS-485)
- Compact, 316 stainless steel enclosure
- Stainless steel sensor
- +/-0.10% (URL) continuous output accuracy
- 4-20mA and/or 1-5 VDC output
- 9-way configurable solid state switch output
- LCD explosion proof display option available
- Available for quick delivery in 48 hours
- For more information, see [Catalog 1587](#)

SOR flow switches and transmitters have proven to be workhorses in the process instrumentation industry. They are ruggedly built to exacting standards and provide long-lasting service.

# FLOW SWITCHES & TRANSMITTERS

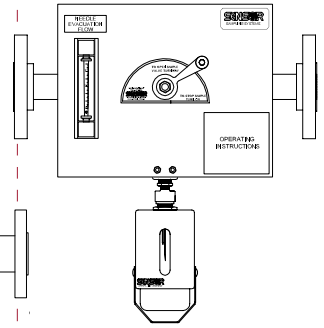
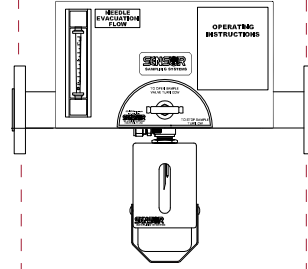

**BBSS**  
Basic Bottle  
Sampling System

150 psig max  
when sampling  
Sample valve and system  
rated up to 2000 psig

135°F max without cooler;  
800°F max with cooler  
& graphoil valve packing

- Simple, flow-thru valve design
- Zero dead volume
- Replaceable process and vent needles
- SENSOR Needle Evacuation System (NES) available
- For more information see [Catalog 1675](#)

**PIBSS**  
Pressure Isolating  
Bottle Sampling  
System

2000 psig @ 70°F

135°F max without cooler  
800°F max with cooler  
& graphoil valve packing

- Guarantees repeatable sample volume
- Zero dead volume
- Replaceable process and vent needles
- Suitable for high process pressures
- SENSOR Needle Evacuation System (NES) standard
- For more information see [Catalog 1680](#)

**LGSS & VSS**  
Liquefied & Vapor Gas  
Sampling Systems

1440 psig (LGSS)  
2000 psig max  
@ 70°F (VSS)

350°F maximum

- Safe, simple methodology for sampling high pressure liquefied gasses and process gasses such as N<sub>2</sub> or H<sub>2</sub>S
- Single handle operation
- Panel mounted pressure gauge
- Sight glass ensures safe cylinder outage
- Ability to depressurize quick connects before removing cylinder
- For more information see [Catalog 1681](#)

**ISS**  
Inline  
Sampling System

1440 psig max  
150 psig max when  
sampling without  
collection cylinder option

800°F with graphoil  
valve packing

- Available in wide variety of piping materials and end connections
- Suitable for high temperature, high viscosity service
- Available with open tube "stinger" or process needle
- SENSOR Needle Evacuation System (NES) available
- For more information see [Catalog 1679](#)

**RSS**  
RAM  
Sampling Systems

1440 psig max  
150 psig max when  
sampling without  
collection cylinder option

800°F with graphoil  
valve packing

- Available in wide variety of piping materials and end connections
- Suitable for high temperature, high viscosity service
- Available with open tube "stinger" or process needle
- SENSOR Needle Evacuation System (NES) available
- For more information see [Catalog 1756](#)

# SAMPLING SYSTEMS

SENSOR Sampling Systems provide a representative sample that is safe to both the operator and the environment. Our systems are designed to meet Leak Detection Repair (LDAR), Maximum Achievable Control Standards (MACT) and Volatile Organic Compounds (VOC) emission standards. Since no two sampling systems are exactly alike, each of our products is engineered to order.

## Hardware is key to reliable SCADA operations

- SOR Controls Group world-class pressure, temperature and level instruments
- Where other manufacturer instruments are required, we select vendors based on our experience and high quality and performance standards
- Central control panel is SENSOR manufactured using plug-and-play components

## Communications collect data and bring it back to a central location

- HART®, Modbus and discrete signals all used
- Wireless, battery powered site radios available for easy installation and reduced costs
- Land-line, cellular, radio, and satellite communications to the server available

## Data collection and reporting are the final piece to make it all worthwhile

- The client owns the server for full control and peace of mind
- Both hardware and Cloud based servers available
- Optional hardware only packages available for users with a preferred data collection network
- Data is reported via graphical screens representative of actual operations for easy, intuitive monitoring
- Alarm notification via text and email available and fully customizable

For more information, see **SENSOR Well Monitoring System, Catalog 1686**

### INPUTS

- Wireless
- Analog (4-20 mA, 1-5v, 0-10v, etc.)
- Discrete
- Digital Comms (modbus, HART®, Profibus, Devicenet, etc.)

### OUTPUTS

- Cell
- Satellite
- Radio
- Ethernet



*Minimize Downtime and Lost Production  
Reduce Costs  
Increase Safety and Compliance  
Improve Operational Performance*

SENSOR Data Monitoring, as part of SOR Controls Group, manufactures high performance measurement devices required for monitoring and controlling each of the four primary process variables used in the safe remote operation and control of a wellsite: Pressure, Temperature, Level, and Flow. The SENSOR Remote Well Monitoring and Control System has a flexible design to provide a multitude of options using off-the-shelf components to meet the requirements of your process conditions. Automate and monitor a single area of the production process and later expand the system for full remote operation.

# DATA MONITORING SYSTEMS

# ENGINEERED TO ORDER

with Off-the-Shelf Speed

Instrumentation and control challenges are inevitable in the oil and gas, petrochemical and power industries. They can range from a simple measurement application to complex system integration issues. When you have a challenge you can choose a solution potentially involving multiple companies and contractors or SOR can provide engineering expertise, custom designs, and produce a solution tailored to your needs.

SOR can customize nearly every standard product we offer, or design, develop and manufacture a custom product to meet your exact specifications. Our mixed-mode capabilities enable us to operate in a job shop environment with an OEM mentality.

We specialize in short-turn projects, but can also handle high-volume work.



Mini-Hermet Pressure Switch custom Pig Launcher on an export flow line for offshore oil production.

- SOR has created over 3,500 unique product configurations to meet customer special requirements
- In the last 10 years, SOR has shipped more than 100,000 special Engineered to Order products
- Over 85,000 square feet of vertically integrated production capability located in Lenexa and Houston
- Products are designed and manufactured to ISO 9001 Standards
- Management system is based on the principles of operational excellence and LEAN enterprise

## ENGINEERING EXPERTISE

SOR is capable of offering fully integrated solutions from design to installation:

### ELECTRICAL/HARDWARE

- Hardware development tools
- Test equipment

### FIRMWARE/SOFTWARE

- Firmware development
- Desktop/Application software development
- Industrial communication protocol experience

### MECHANICAL DESIGN

- Mechanical design development and prototyping tools
- Full drafting capabilities including 3-D modeling
- Finite element analysis (FEA)
- Research and Development: comprehensive testing and evaluation capabilities

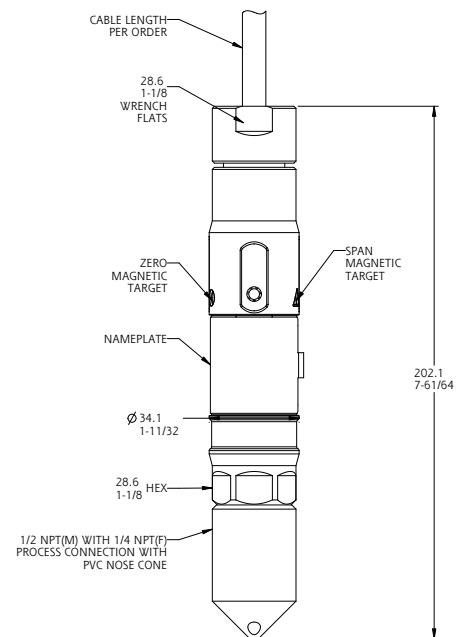



# MANUFACTURING CAPABILITIES



## MACHINING

- Precision machinists/tool & die makers
- CNC machining centers
- Full tool & die design, machining and fabrication



## WELDING & FABRICATION

- Certified MIG/TIG Welders
- Level II NDE/Certified Weld Inspector on staff
- ASME Section IX and AWS D2.1 qualified welding system
- Panasonic Perform Arc 122S robotic weld centers
- Capability to produce to ASME B31.1 & B31.3



## ASSEMBLY, PAINT, TEST AND CALIBRATION

- Vertically integrated assembly, painting and test process capability
- Manufacturing and quality engineers dedicated to production operation

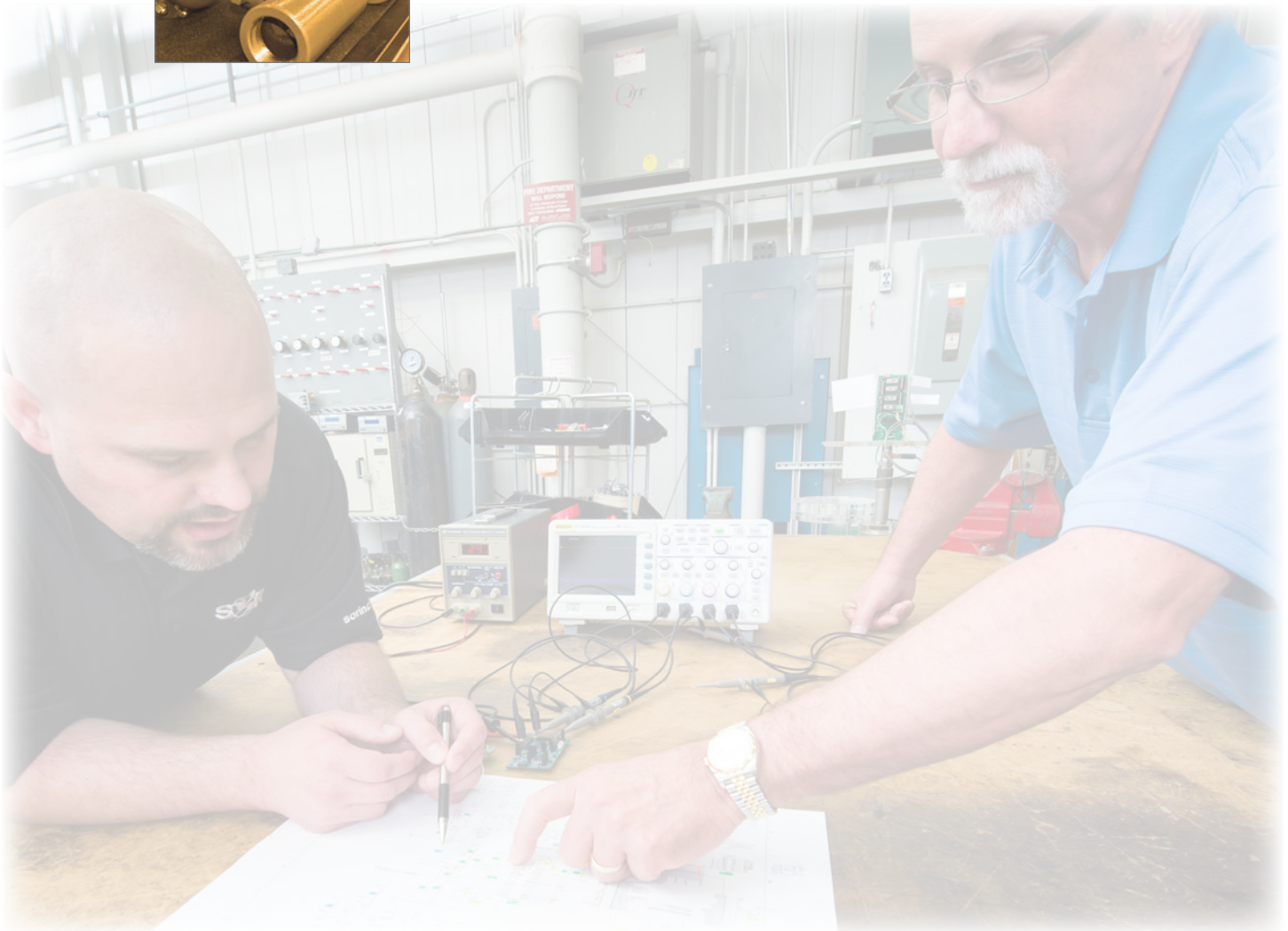

## Diaphragm Seals

SOR Diaphragm Seals are custom-manufactured by trusted partners such as ReoTemp Instruments, a leading supplier of diaphragm seals with many years of experience in specialty seals.

SOR is ready to work with customers on any high-performance chemical seal application such as high vacuum, high temperature, high sterility, custom design, high static pressure/low differential span or high vacuum/high temperature.



### THREADED SEALS

- Standard or large area (more sensitive) diaphragm with optional flushing port
- 30 inHg vac to 2500 psi
- Isolates sensor
- All 316SS
- Welded construction
- Custom assemblies & materials available



### FLANGED SEALS

- Standard or large area (more sensitive) diaphragm with optional flushing port
- Pipe sizes: 1, 1½, 2, 3, or 4"
- 30 inHg vac to 2500 psi
- Isolates sensor
- All 316SS
- Welded construction
- Custom assemblies & materials available



### SANITARY SEALS

- Tri-Clamp design for:  
¾, 1, 1½, 2, 2½, or 3" pipe
- 30 inHg vac to 600 psi
- Sanitary isolation of sensor
- Quick connecting tri-clamp
- Meets 3A sanitary standards



## Hazardous Area Classification

Hazardous Areas are locations where the potential for fire or explosion exists because of gases, dust or easily ignitable fibers in the atmosphere.

In North America, hazardous areas are separated by classes, divisions, and groups to define the level of safety required for equipment installed in these locations. Classes define the general form of the flammable materials in the atmosphere. Divisions define the probability of the presence of flammable materials. Groups classify the exact flammable nature of the material.



In Europe and countries outside of North America, classification of hazardous areas is accomplished differently. Zones are used to define the probability of presence of the flammable materials. Protection Types denote the level of safety for the device. Groups classify the exact flammable nature of the material. These groups are separated differently than North American Groups. Temperature Identifications convey the maximum surface temperature of the apparatus based on 104°F (40°C) ambient. These temperature codes are selected carefully so as not to exceed the ignition temperature of the specific gas or vapor to be encountered in the application.

## Environmental Protection

Similar to hazardous location classifications, environmental protection ratings are slightly different within and outside of North America. National Electrical Manufacturers Association (NEMA) and Ingress Protection (IP) Codes provide similar information regarding protection against specified environmental conditions.

|                |  |
|----------------|--|
| <b>NEMA 4</b>  | Indoor or outdoor use. Protection against wind-blown dust and rain, splashing water, hose-directed water and damage from external ice formation. |
| <b>NEMA 4X</b> | NEMA 4, plus protection against corrosion.   |
| <b>IP 65</b>   | Dust-tight and protected against water jets.   |
| <b>IP 68</b>   | Dust-tight and suitable for indefinite immersion.  |

Some classifications are not shown here. For further detailed information, see specific standards published by approval organizations.

# Certifications and Approvals

Each year, inspectors from the International Organization for Standardization (ISO) visit SOR Inc. It's their job to make certain that our manufacturing processes meet stringent goals for product quality and employee safety. SOR has earned the ISO 9001 certification each year for the past decade. ISO certification ensures that we're doing things right for our employees while creating the highest quality products for our customers.

Additionally, many other products are approved for ordinary locations and hazardous locations. Various protection concepts used include Intrinsically Safe (IS) and explosion proof/flameproof. SOR offers Safety Integrity Level (SIL) certified products for its entire range of switches. SIL pressure and level switches are certified to the IEC 61508 safety standard.

SOR regularly undergoes nuclear audits by NUPIC, NIAC and TSSA (CSA M 285.0).

## Agency Approvals

SOR products satisfy the requirements of approval agencies worldwide. Often, a common design is capable of multiple approvals. In other cases, modified construction techniques are necessary to meet specific agency requirements.



|   |   |   |   |
|---|---|---|---|
|  | ATEX (BASEEFA, FM, SIRA)  |  | INMETRO   |
|  | TestSafe (Australia)  |  | Technology Institution of Industrial Safety               |
|  | Canadian Standards Association  |  | <b>KOSHA</b> Korean Occupational Safety and Health Agency |
|  | CE Marked   |  | SASO  |
| CRN   | CRN   |  | Underwriters Laboratories                                 |
|  | Factory Mutual  |  | IEC (International Electrotechnical Commission)           |
|  | SOR products are certified to IEC 61508 for non-redundant use in SIL1 and SIL2 Safety Instrumented Systems for most models. Heavy Industrial (Self-Certified) |  | Taiwan Safety   |



# General Applications



## CHEMICAL/PETROCHEMICAL/REFINING:

- Distillation Column
- Coker Unit
- Hydrodesulphurization (HDS) Unit
- Fluid Catalytic Cracking Unit (FCCU)
- Semi-Regenerative Catalytic Reformer Unit (SRRU)
- Hydrofluoric Acid Alkylation Unit (HFAU)
- Flare Knockout Drum
- Sump Level Control

## OIL & GAS

- Wellhead Control Panel (WHCP)
- Test Separator
- Casing & Tubing Pressure Monitoring
- Chemical Injection Skid
- Frac Sand Recovery Vessel
- Offshore Production Export Line
- Pipeline Flow Monitoring
- Tank Battery
- Residential Gas Utility
- Slug Catcher

## POWER GENERATION

- Boiler Feed Water
- Coal-Fired Power Plant
- Auxiliary Steam System
- Water Level Temperature Fluctuations
- Steam Turbine Drip Leg
- Hotwell Condenser
- Demineralization Unit
- Steam Drum Level
- Flue Gas Wet Scrubber
- Liquid Fuel Storage Vessel

## WATER & WASTEWATER

- Pump Over-Pressurization Protection
- Storm Water Level
- Flocculation Basin
- Primary Clarifier Level
- Secondary Treatment Bioreactor
- Biogas Pressure
- Sanitation System
- Septic Tank
- Sludge Air-Drying
- Osmotic Filter Integrity

## OTHER

- Pulp & Paper Plant
- Lube Oil System
- Cyclone Separator
- High Level Alarm Safety Shutoff

## STRATEGIC DIRECTION

- VISION** We will be our customers' preferred partner for measurement and control.
- MISSION** We leverage our ability and willingness to develop engineered solutions from standard product platforms to create value for our customers.

## STRATEGIC VALUES

- QUALITY**
- We focus on the quality of our products
  - We value the quality of our relationships with our customers, our representatives, and our associates
  - We work to ensure the quality of data we share
- DELIVERY**
- We protect the integrity of our lead times (On-time delivery)
  - We work quickly and efficiently
  - We act with a sense of urgency
  - We are reliable
  - We keep our promises
- CUSTOMER SERVICE**
- We focus on helping the customer
  - We go out of our way to help solve problems
  - We are willing to do the right thing, even when it's the "hard" thing
  - We make every customer feel like they are the only one we want



MEASUREMENT AND CONTROL



### **SALES OFFICES**

**Beijing, China** | +86 10 5820 8767 | Fax +86 10 5820 8770

**Chennai, India** | +91 735 838 8250 | Fax 913-312-3572

**Dubai, UAE** | +971 4 278 9632 | Fax 913-312-3596

**Houston, TX, US** | 281-272-5333 | Fax 281-272-5332

**Lenexa, KS, US** | 913-888-2630 | Fax 913-888-0767

**London, United Kingdom** | 913-956-3092 | Fax 913-312-3571



MEASUREMENT AND CONTROL